

Operating instructions

Washing machine

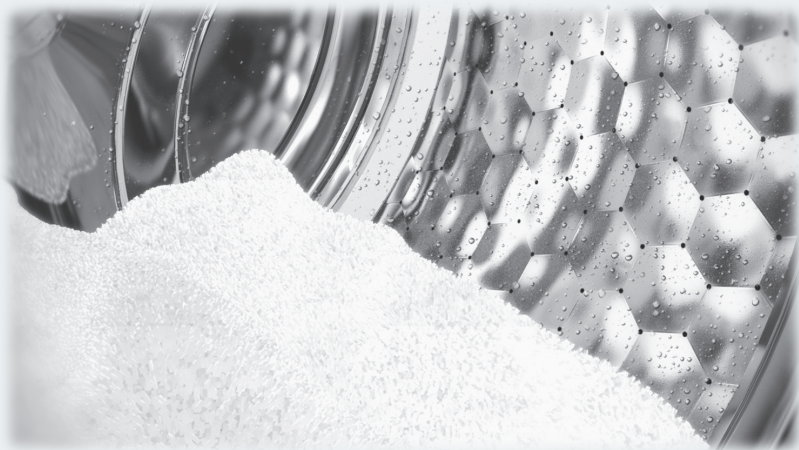

To avoid the risk of accidents or damage to the appliance, it is **essential** to read these instructions before it is installed and used for the first time.

Caring for the environment

Disposal of the packing material

The packaging is designed to protect the washing machine from damage during transportation. The packaging materials used are selected from materials which are environmentally friendly for disposal and should be recycled.

Recycling the packaging reduces the use of raw materials in the manufacturing process and also reduces the amount of waste in landfill sites. Ensure that any plastic wrappings, bags etc. are disposed of safely and kept out of the reach of babies and young children. Danger of suffocation.

Disposing of your old appliance

Electrical and electronic appliances often contain materials which, if handled or disposed of incorrectly, could be potentially hazardous to human health and to the environment. They are, however, essential for the correct functioning of your appliance. Therefore, please do not dispose of your old appliance with your household waste.

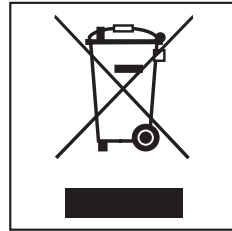

Please dispose of it at your local community waste collection / recycling centre.

Ensure that your old appliance presents no danger to children while being stored for disposal.

Caring for the environment	2
Warning and Safety instructions	6
Operating the washing machine	13
Before using for the first time	15
Running the first programme	15
Washing environmentally and economically	16
1. Preparing the laundry	17
2. Selecting a programme	18
Switching on Delay Start (if required).....	18
3. Loading the washing machine	19
Opening the door	19
4. Selecting programme settings	20
Selecting Extras	20
5. Adding detergent	21
6. Starting the programme - the end of the programme	22
Extras	23
Short	23
Pre-wash	23
Soak	23
Water plus	23
Spinning	24
Delay start	25
Programme chart	26
Garment care label symbols	29
Programme sequence	30

Contents

Changing the programme sequence	32
Cancelling a programme.....	32
Removing laundry after cancelling the programme.....	32
Interrupting a programme.....	32
Changing a programme and settings.....	32
Programme.....	32
Temperature.....	32
Spin speed.....	32
Extras.....	32
Adding or removing laundry after a programme has started.....	33
Detergent	34
The correct detergent.....	34
Definition of the soiling level.....	34
Detergent dispensing aids.....	34
Water softeners.....	34
Fabric softeners and liquid starch.....	34
Miele recommended detergents.....	35
Adding fabric softener or liquid starch separately.....	37
Cleaning and care	38
Cleaning the drum.....	38
External casing and fascia panel.....	38
Cleaning the detergent dispenser drawer.....	38
Cleaning the water inlet filter.....	40
Problem solving guide	41
Problem solving guide.....	41
The programme does not start.....	41
The wash programme stops and a fault indicator light comes on.....	42
A check or fault indicator light comes on but the wash programme continues as normal.....	43
General problems with the washing machine.....	44
An unsatisfactory wash result.....	45
The door will not open.....	46
Opening the door in the event of a blocked drain outlet and/or power cut.....	47
Procedure for draining the washing machine.....	47
Opening the door.....	48

After sales service	49
Repairs	49
Warranty	49
Optional accessories	49
Installation and connection	50
Front view	50
Installation surface	52
Removing the transit bars	52
Refitting the transit bars	54
Levelling the machine	55
Screwing out and adjusting the feet	55
Building under a continuous worktop / in a kitchen run	56
Washer and dryer stack	56
The Miele water protection system	57
Connection to the water supply	58
Drainage	59
Electrical connection	60
Technical data	61
Consumption data	62
Consumption data for the nominated energy labelling programme according to AS/NZS 2040.1 & AS/NZS 2040.2	62
Programmable functions	64
Water plus system	64
Gentle action	65
Suds cooling	66
Memory	67
Soak duration	68
Optional accessories	69
Detergent	69
Specialist detergents	69
Fabric care	70

Warning and Safety instructions

This washing machine complies with current safety requirements. Inappropriate use can, however, lead to personal injury and damage to property.

To avoid the risk of accidents and damage to the machine, please read these instructions carefully before using it for the first time. They contain important information on its safety, use and maintenance.

Keep these instructions in a safe place and ensure that new users are familiar with the content. Pass them on to any future user.

Correct application

- ▶ This washing machine is designed for domestic use and for use in similar environments by guests in hotel or motel rooms, bed & breakfasts and other typical living quarters. This does not include common/shared facilities or commercial facilities within hotels, motels or bed & breakfasts.
- ▶ The washing machine is not suitable for outdoor use.
- ▶ It must only be used to wash garments which have been declared suitable for washing by the manufacturer indicated on the garment care label. Any other use is not permitted. Miele cannot be held liable for damage resulting from incorrect or improper use or operation.
- ▶ This washing machine is not intended for use by persons (including children) with reduced physical, sensory or mental capabilities, or lack of experience and knowledge, unless they have been given supervision or instruction concerning its use by a person responsible for their safety.

Safety with children

- ▶ Young children must not be allowed to use this appliance.
- ▶ Older children may only use the appliance when its operation has been clearly explained to them and they are able to use it safely, recognising the dangers of misuse.
- ▶ Cleaning work may only be carried out by older children under the supervision of an adult.
- ▶ Please supervise children in the vicinity of the washing machine and do not let them play with it.
- ▶ For machines with a 'porthole' door, remember that the porthole glass will be hot when washing at very high temperatures. Do not let children touch it.

Technical safety

- ▶ Please observe the instructions in "Installation and connection" and "Technical data".
- ▶ Before setting up the washing machine, check it for any externally visible damage. Do not install or use a damaged machine.
- ▶ Before connecting the washing machine, ensure that the connection data on the data plate (fuse rating, voltage and frequency) matches the mains electricity supply. If in any doubt, consult a qualified electrician.

Warning and Safety instructions

- ▶ Reliable and safe operation of this washing machine can only be assured if it has been connected to the mains electricity supply.
- ▶ The electrical safety of this washing machine can only be guaranteed when continuity is complete between it and an effective earthing system which complies with current local and national safety regulations. It is most important that this basic safety requirement is present and regularly tested and, where there is any doubt, the household wiring system should be inspected by a qualified electrician. Miele cannot be held liable for the consequences of an inadequate earthing system (e.g. electric shock).
- ▶ Do not connect the washing machine to the mains electricity supply by a multi-socket adapter, extension lead or similar. These do not guarantee the required safety of the machine (fire hazard due to the risk of overheating).
- ▶ Faulty components must only be replaced by genuine Miele spare parts. Miele can only guarantee the safety of the appliance when Miele replacement parts are used.
- ▶ The electrical socket must be easily accessible after installation so that the machine can be disconnected from the electricity supply if necessary.
- ▶ Unauthorised repairs could result in unforeseen dangers for the user, for which Miele cannot accept liability. Repairs should only be undertaken by a Miele authorised service technician, otherwise any subsequent damage will not be covered by the warranty.
- ▶ If the connection cable is faulty, it must only be replaced by a Miele approved service technician to protect the user from danger.

Warning and Safety instructions

- ▶ In the event of a fault or for cleaning purposes, the washing machine is only completely isolated from the electricity supply when:
 - it is switched off at the wall socket and the plug is withdrawn, or
 - it is switched off at the mains circuit breaker.
- ▶ The Miele Waterproof system protects from water damage provided the following conditions have been met:
 - The machine is correctly plumbed in and connected to the electricity supply.
 - If a fault or damage has been identified, the machine must be examined by a competent person before further use, and repaired if necessary.
- ▶ The water flow pressure must be at least 100 kPa and should not exceed 1000 kPa.
- ▶ This washing machine must not be installed and operated in mobile installations (e.g. on a ship).
- ▶ In areas which may be subject to infestation by cockroaches or other vermin, pay particular attention to keeping the machine and its surroundings in a clean condition at all times. Any damage which may be caused by cockroaches or other vermin will not be covered by the machine warranty.
- ▶ Do not make any alterations to the machine, unless authorised to do so by Miele.

Warning and Safety instructions

Correct use

- ▶ Do not install the washing machine in a room where there is a risk of frost. Frozen hoses may burst or split. The reliability of the electronic control unit may be impaired at temperatures below freezing point.
- ▶ Before using the machine for the first time, check that the transit bars at the rear of the machine have been removed (see "Installation and connection - Removing the transit bars"). During spinning, a transit bar which is still in place may result in damage to both the machine and adjacent furniture or appliances.
- ▶ Turn off the tap if the machine is to be left for any length of time (e.g. holiday), especially if there is no floor drain (gully) in the immediate vicinity.
- ▶ Flooding danger.
If hooking the drain hose into a wash basin, check that the water can drain off quickly enough to prevent the sink from overflowing. Make sure the drain hose is secure, so that the force of the water flowing out of the hose does not dislodge it.
- ▶ Take care to ensure that foreign objects (e.g. nails, pins, coins, paper clips) do not find their way into the machine with the laundry. These may damage components of the machine (e.g. suds container, drum), which in turn can result in damage to the laundry.

Warning and Safety instructions

- ▶ The maximum load for this washing machine is 7 kg (dry weight). See the "Programme chart" for the maximum recommended loads for individual programmes.
- ▶ If the correct amount of detergent is dispensed, the machine should not need to be descaled. If, however, you do wish to descale it, only use a proprietary natural citric acid based descaling agent. Miele recommends using Miele descaler for washing machines which is available to order online at www.miele-shop.com (depending on country) or from Miele. Strictly observe the instructions on the packaging.
- ▶ Textiles which have been pre-treated in solvent based cleaning agents must be thoroughly rinsed in clean water before being washed in the machine.
- ▶ Do not use solvent based cleaning agents, e.g. those containing benzene, in this machine, as this may result in damage to component parts and create toxic fumes. Such agents also pose a fire and explosion hazard.
- ▶ Do not use solvent based cleaning agents, e.g. those containing benzene, to clean the external surfaces of the machine. They can cause damage to plastic surfaces.
- ▶ Only use dyes specified by the manufacturer as being suitable for use in a domestic washing machine. Always observe the manufacturer's instructions carefully.

Warning and Safety instructions

- ▶ Colour run and dye removers contain sulphur compounds which can cause damage such as corrosion. Do not use these products in this machine.
- ▶ If detergent comes into contact with the eyes, rinse them thoroughly with lukewarm water immediately. If swallowed, seek medical assistance immediately and retain the packaging or label for reference. Those with skin problems or sensitive skin should avoid their skin coming into contact with detergent.

Accessories

- ▶ Only use genuine Miele spare parts and accessories with this appliance. If spare parts or accessories from other manufacturers are used, this will invalidate the warranty, and Miele cannot accept liability.
- ▶ A Miele tumble dryer can be stacked on top of a Miele washing machine using the appropriate stacking kit (available as an optional accessory). Please make sure you order the correct one for the Miele washing machine and Miele tumble dryer.

Miele cannot be held liable for damage caused by non-compliance with these Warning and Safety instructions.

Operating the washing machine

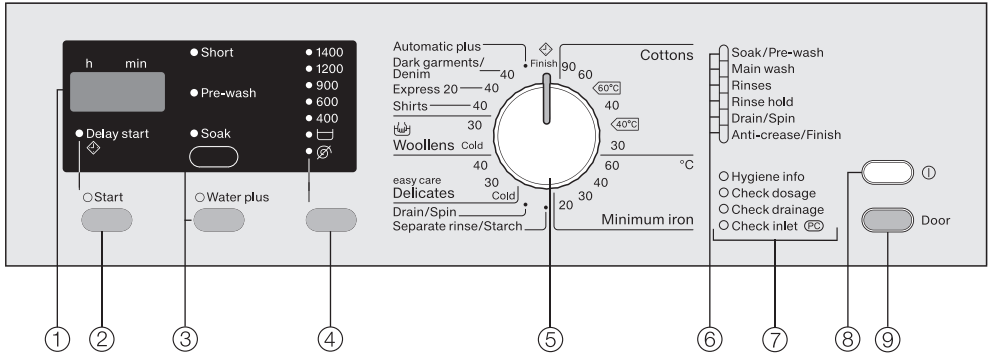

① Display

See the next page for more information.

② Start button

- For selecting Delay start.
- For starting the wash programme.

③ Extra option buttons

For selecting Extra options. Use the upper button to select *Short*, *Pre-wash* or *Soak*. Use the lower button to select *Water plus*.
Indicator light on = option selected
Indicator light off = option not selected

④ Spin button with spin speed indicator lights

For selecting the spin speed.

⑤ Programme selector

For selecting the wash programme and temperature for that programme. The programme selector can be turned clockwise or anti-clockwise.

⑥ Programme sequence indicator lights

Show which stage of the programme has been reached.

⑦ Check / Fault indicator lights

- See "Problem solving guide".
- The PC check light is also used by service technicians to run diagnostic checks and may be used to update programming data in the future.

⑧ 1 button

For switching the washing machine on and off.

To save energy, the washing machine will switch off automatically 15 minutes after the end of the programme/anti-crease phase or after being switched on if no other selection is made.

⑨ Door button

For opening the door.

Operating the washing machine

Display

The display shows:

- the programme duration (Time left display)
- the Delay start function
- the programmable functions

Programme duration

After the programme has started, the programme duration will appear in the display in hours and minutes.

When Delay start is being used, the programme duration will appear after the Delay start time has elapsed.

Delay start

The Delay start time selected will appear in the display.

After the programme has started, the Delay start time will begin to count down.

Once the Delay start time has finished, the programme begins and the estimated programme duration appears in the display.

Programmable functions

The programmable functions can be used to tailor washing programmes to suit your personal requirements. In programming mode, the display will show the function selected.

Before using for the first time

 Before using the machine for the first time, ensure that it is correctly installed and connected. See "Installation and connection". Also check that the filters are securely tightened to prevent the risk of water leaks during use.

This washing machine has undergone a complete functional test at the factory and there will be some residual water in the drum from this process.

For safety reasons, spinning is not possible until the machine has been prepared for using for the first time. To activate the spinning function, you must run a wash programme without laundry and without detergent.

Using detergent could result in an excessive build-up of foam.

This also activates the ball valve. The ball valve prevents detergent escaping from the suds container into the sump during a wash programme, thus making maximum use of the detergent.

Running the first programme

- Turn on the tap.
- Press the  button in.
- Turn the programme selector to *Cottons 60°C*.
- Press the *Start* button.

When the programme has finished, your machine is ready to use for the first time.

- Switch the washing machine off with the  button at the end of the programme.

Washing environmentally and economically

Energy and water consumption

- Water consumption and energy usage are determined by the size of the load.
To make the most out of your machine, load the maximum dry load for the programme you are using.
- When smaller amounts of laundry are washed, the automatic load recognition system will reduce the amount of water and energy used.
- Use the *Express 20* programme for small, lightly soiled loads.
- Modern detergents make it possible to wash at lower temperatures (e.g. 20°C). Washing using lower temperature settings will save energy.
- Use the *Soak Extra* option instead of *Pre-wash*. If Soak is followed immediately by a main wash, the same suds are used.
- To maintain the hygiene of the machine, carry out a hot wash (60°C or above) using powder detergent at regular intervals. The *Hygiene info* check light will appear to remind you to carry out a hot wash.
- Using the *Cottons* $\langle 40^{\circ}\text{C} \rangle$ programme is recommended for a normally soiled load and is the programme used in energy/water consumption tests in accordance with AS/NZS 2040 (refer to "Consumption data").

Detergent consumption

- Do not exceed the amounts of detergent recommended by the manufacturer on the packaging.
- Adjust the dosage to the degree of soiling of the laundry.
- Reduce the amount of detergent with smaller loads (approx. $\frac{1}{3}$ less than the amount recommended can be used when washing a half load).

Choosing the correct Extra option (Short, Soak, Pre-wash)

Select:

- a wash programme together with the *Short Extra* option for light to moderate soiling where there are no obvious marks.
- a wash programme without any Extra options for moderate to heavy soiling with visible staining.
- a wash programme together with the *Soak Extra* option for heavily soiled laundry.
- the *Pre-wash Extra* option for laundry with large amounts of dirt (e.g. dust, sand).

When drying with a tumble dryer

Selecting the highest possible spin speed for the wash programme will save energy when drying in a tumble dryer afterwards.

1. Preparing the laundry

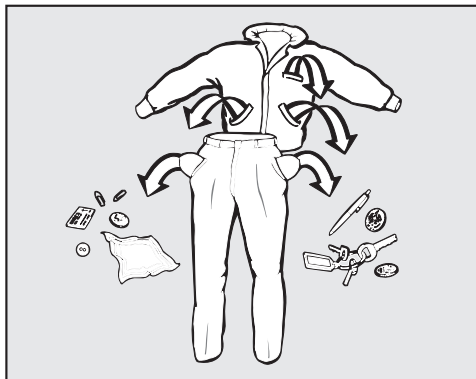

- Empty all pockets.

⚠ Foreign objects (e.g. nails, coins, paper clips, etc.) can cause damage to garments and components in the machine.

Sorting the laundry

- Sort the laundry by colour and by care label. Most garments have a textile care label in the collar or side seam.

Useful tip: Dark textiles often contain excess dye and should be washed separately several times before being included in a mixed load. Always wash white and coloured items separately.

Pre-treating stains

- Badly soiled areas, stains etc. should be cleaned as soon as possible, preferably while still fresh. Spillages should be carefully dabbed off using a soft, colourfast cloth. Do not rub.

Useful tip: Stains can be pre-treated using some handy tricks, which can be found in "Miele's guide to laundry care". Please contact Miele to obtain a copy of this booklet.

⚠ If you use a solvent-based cleaning agent (e.g. one containing benzene) to pre-treat a stain, make sure that any plastic parts (e.g. buttons) are protected, and that the cleaning agent is rinsed off before washing the garment in the machine.

⚠ Do not use solvent-based cleaning agents in or on this machine.

General tips

- Curtains: Remove lead weights first or place in a laundry bag.
- Underwiring and collar stiffeners: Any loose wiring in bras, shirt collar stiffeners, etc. should be removed or sewn in.
- Close any zips, attach velcro fasteners, fasten hooks and eyes etc. before washing.
- Fasten duvet covers and pillow cases to prevent small items from being rolled up inside them.

Do not wash any items in this machine which are specified by the manufacturer as **not washable** on the care label (☒ symbol).

2. Selecting a programme

Switching on the washing machine

- Press the  button.

Switching on Delay Start (if required)

Make sure the programme selector is at the *Finish* position .

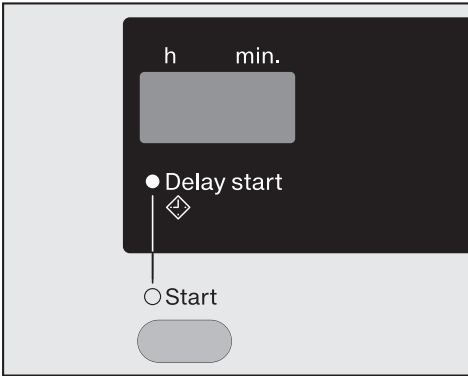

- Press the *Start* button repeatedly to select the delay time you want.

Useful tip: Please see "Delay start" for more information.

Programme selection

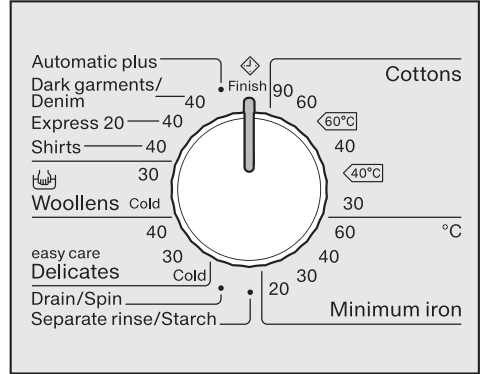

- Turn the programme selector to the required programme.

The display will show the estimated programme duration (unless you have selected a Delay start time).

During the first 10 minutes, the machine measures how much water is being absorbed by the laundry. The programme duration may be longer or shorter depending on the absorbency rate.

3. Loading the washing machine

Opening the door

- Press the *Door* button to open the drum door.
- Unfold the laundry and load loosely in the drum.

Mixing both large and small items gives better wash results and also helps distribute the load evenly during spinning.

Please note the maximum load for the different wash programmes.

The most efficient use of energy and water is achieved when a full load is washed. However, do not overload as this reduces cleaning efficiency and causes creases.

Closing the door

Make sure that no items are caught between the door and the seal.

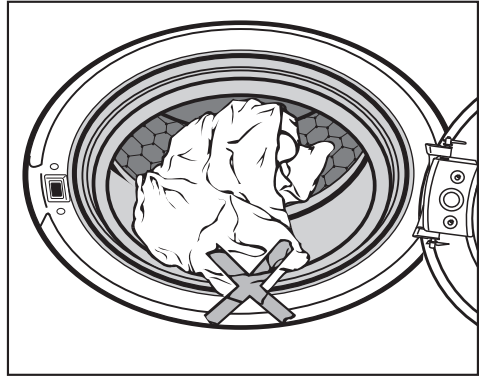

- Shut the door with a gentle swing.

4. Selecting programme settings

Selecting Extras

Each press of the upper button selects the Extra options: *Soak* or *Pre-wash* or *Short* or no Extra option.

Use the lower button to select the *Water plus* Extra option.



- Select the Extra option(s) you want.

Useful tip: Not all the Extra options can be used with every programme.

You can only select Extra options which are compatible with the programme being used.

Selecting a spin speed

You can alter the preset spin speed of a wash programme.

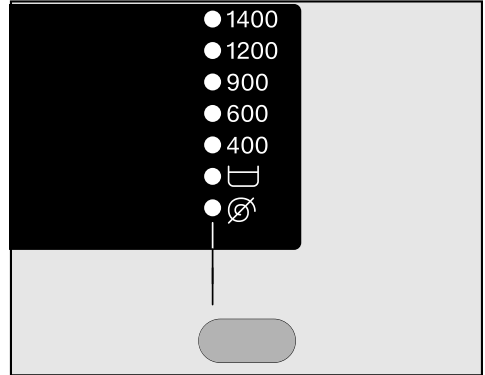

- Press the Spin button repeatedly until the indicator light of the spin speed you want comes on.

5. Adding detergent

It is important to dispense the correct amount, because . . .

. . . too little detergent results in:

- laundry not getting properly clean and with time it may become grey and hard to the touch.
- greasy particles clinging to the laundry.
- limescale deposits on the heater elements.

. . . too much results in:

- excessive foam which causes a low level of agitation and poor wash, rinse and spin results.
- high water consumption (an additional rinse cycle will automatically switch in).
- a burden to the environment.

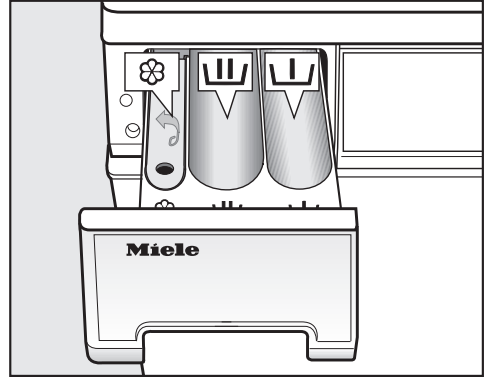

- Pull out the detergent drawer and add detergent to the compartments.



Detergent for the pre-wash (divide the total recommended amount as follows: add $\frac{1}{3}$ to compartment U and $\frac{2}{3}$ to compartment U)



Detergent for the main wash, including Soak if selected



Fabric softener or liquid starch

- Close the detergent dispenser drawer.

Useful tip: See "Detergent" for further information.

6. Starting the programme - the end of the programme

Starting the programme

- Press the flashing *Start* button.
- The programme duration will appear in the display once the programme has started.
- If a Delay start time has been selected, this will count down in the display until the programme starts. The programme duration will then appear in the display.

At the end of the programme

When the programme has finished, the *Anti-crease/Finish* indicator light will light up in the programme sequence display and  will appear in the display.

The washing machine will switch off automatically 15 minutes after the end of the anti-crease phase. Press the  button to switch it back on again.

- Press the *Door* button to open the drum door.
- Remove the laundry.

Check that all items have been removed from the drum. Items left in the drum could discolour other items in the next wash or become discoloured themselves.

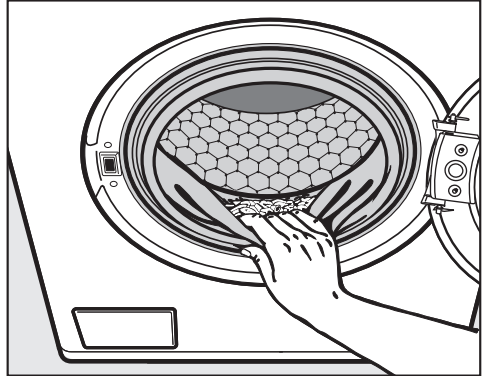

- Check the folds in the door seal for any small articles, e.g. buttons, which might be lodged there.
- Switch the washing machine off with the  button and turn the programme selector to *Finish*.
- Close the door. Otherwise there is a danger of objects being placed inadvertently in the drum. If these remained unnoticed and were washed in the next load, they could damage the laundry. An open door is also a danger to pets and children.

You can use the Extra option buttons to augment the wash programmes.

Short

For light soiling with no visible staining.

The wash duration is reduced.

Pre-wash

For laundry with large amounts of dirt, e.g. dust and sand.

Soak

For heavily soiled and stained items with protein stains.

- A duration of between 30 minutes and two hours can be programmed in 30-minute increments for the soak process.
- The factory default setting is two hours.

See "Programmable functions - Soak" for instructions on how to programme a different soak period.

Water plus

The water level in the main wash and the rinses will be increased if the Water plus option is selected.

However, you can select other settings for *Water plus*. These are described in "Programmable functions".

Selectable Extra options

Only one of the following Extra options can be selected at a time: *Short*, *Pre-wash* and *Soak*.

	Short	Pre-wash	Soak	Water plus
Cottons	X	X	X	X
Minimum iron	X	X	X	X
Automatic plus	-	-	-	-
Dark garments/ Denim	X	X	X	-
Express 20	X ¹⁾	-	-	X
Shirts	X	X	X	X
Woolens 	-	-	-	-
Delicates	X	X	X	-
Drain/Spin	-	-	-	-
Separate rinse/ Starch	-	-	-	X

X = Can be selected

- = Cannot be selected

1) = Can be deselected

Spinning

Final spin speed

Programme	rpm
Cottons	1400
Minimum iron	1200
Automatic plus	1200
Dark garments/Denim	1200
Express 20	1400
Shirts	600
Woolens 	1200
Delicates	600
Drain/Spin	1400
Separate rinse/Starch	1400

You can reduce the final spin speed. However, you cannot select a final spin speed higher than that shown in the chart above.

Useful tip: For programmes with a maximum spin speed not shown on the control panel, the nearest spin speed above it will light up. However, to protect the laundry, the machine will only spin at the spin speed quoted in the chart.

Rinse and interim spin

There is a spin after the main wash and between the rinses. A reduction in the final spin speed will also reduce the interim spin speed. If a spin speed of less than 700 rpm is selected for the *Cottons* programme, an additional rinse is introduced.

Omitting the final spin (Rinse hold)

- Press the Spin button until the  (Rinse hold) indicator light comes on. The laundry will not be spun and will remain suspended in the final rinse water. This reduces creasing if the laundry is not going to be removed immediately after the end of the programme.
- Starting the final spin:
Use the Spin button to select the spin speed you want. The machine will begin the final spin.
- Press the *Door* button. The water will drain away. Press the *Door* button again to open the door.

Omitting rinse and interim spin and the final spin

- Press the Spin button repeatedly until the  light comes on.

After the last rinse, the water will be pumped away and the anti-crease phase will switch in. In some programmes an additional rinse is introduced with this setting.

With Delay start you can choose when you want the programme to start. You can delay the start of the programme by 30 minutes up to a maximum of 24 hours, allowing you to make use of night-time economy electricity rates, for example.

Switching on Delay start

Make sure the programme selector is at the *Finish* position .

The *Delay start* indicator  will flash in the display.

You can now use the Start button to select the Delay start time you want.

Make sure the programme selector is at the *Finish* position .

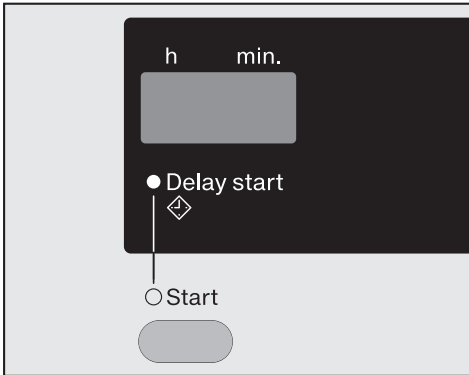

■ Press the *Delay start* button. Each press on the button increases the Delay start time:

- by 30 minutes up to 10 hours
- by 1 hour from 10 hours upwards

Useful tip: Holding the *Start* button pressed in automatically increases the duration up to 24 hours.

Altering Delay start

It is not possible to alter the Delay start time after the programme has been selected.

Cancelling Delay start

- Press the *Start* button again when *24 h* appears in the display.



Cancelling Delay start after you have pressed the Start button

- You will have to cancel the programme.

Programme chart

Cottons		30°C to 90°C	Max. load 7.0 kg
Items	Cottons, linens or cotton mix fabrics, e.g. table linen, towelling, underwear, T-shirts etc.		
Note	Where particularly high levels of hygiene are required, please select a temperature of 90°C.		
Cottons		60°C	Max. load 7.0 kg
Items	Cottons, linens or cotton mix fabrics, e.g. table linen, towelling, underwear, T-shirts etc.		
Notes	With 60°C the actual wash temperature reached will be lower than 60°C although the wash performance is the same as with the standard Cottons 60°C programme.		
Cottons		40°C	Max. load 7.0 kg
Items	Normally soiled cotton garments		
Notes	These settings are the most efficient in terms of energy and water consumption for washing cottons.		
Energy labelling programme according to AS/NZS 2040.1 & AS/NZS 2040.2			
Minimum iron		20°C to 60°C	Max. load 3.0 kg
Items	Synthetic, mixed fibre and easy care cotton.		
Note	Reduce the spin speed for fabrics which crease easily.		
Automatic plus		40°C	Max. load 5.0 kg
Items	Mixed loads of garments suitable for the <i>Cottons</i> and <i>Minimum iron</i> programmes. Sort according to colour.		
Note	The wash parameters (e.g. water level, wash rhythm and spin speed) are adjusted automatically in this programme to ensure the best possible care and wash result for each item.		

Programme chart

Dark garments/ Denim		40°C	Max. load 3.0 kg
Items	Black and dark garments made from cotton, mixed fibres and denim.		
Notes	<ul style="list-style-type: none"> – Wash inside out. – Denim often contains excess dye and may run during the first few washes. Wash light and dark coloured items separately. 		
Express 20		40°C	Max. load 3.5 kg
Items	Cotton garments that have hardly been worn or are only very lightly soiled.		
Note	The <i>Short Extra</i> option is activated automatically.		
Shirts		40°C	Max. load 2.0 kg
Notes	<ul style="list-style-type: none"> – Pre-treat collars and cuffs if necessary. – Wash silk shirts and blouses in the <i>Silks</i>  programme. 		
Woollens 		Cold and 30°C	Max. load 2.0 kg
Items	Machine-washable or hand-washable wool or wool blend fabric. If the care label does not specify a temperature, wash using the cold setting.		
Note	Reduce the spin speed for items which crease easily.		
Delicates		Cold to 40°C	Max. load 2.0 kg
Items	<p>Delicate garments made from synthetic fibre, mixed fibre, rayon and viscose.</p> <p>Curtains, including net curtains, specified as machine-washable by the manufacturer.</p>		
Notes	<ul style="list-style-type: none"> – Dust in curtains usually makes using a programme with a pre-wash advisable. – For items which crease easily, deselect the spin. 		

Programme chart

Drain/Spin		–
Notes	<ul style="list-style-type: none">– Drain only: Select  for the spin speed.– Make sure you select the appropriate spin speed.	
Separate rinse/Starch		Max. load 7.0 kg
Items	<ul style="list-style-type: none">– For rinsing hand-washed items.– Starching table cloths, serviettes and workwear.	
Notes	<ul style="list-style-type: none">– Reduce the spin speed for items which crease easily.– Laundry that is to be starched should be washed but not treated with fabric softener.– Items will be rinsed very effectively using two rinse cycles by activating the <i>Water plus</i> Extra option. The <i>P2</i> or <i>P3</i> option of the <i>Water plus</i> system programmable function must be activated.	

Garment care label symbols

Washing	
The figure quoted in the bucket is the maximum temperature at which the garment can be washed. The number of bars under the symbol indicates the level of agitation permitted.	
	No bar under the symbol = normal agitation
	One bar under the symbol = reduced agitation
	Two bars under the symbol = much reduced agitation
	Hand wash (If no temperature is specified, use the lowest temperature or cold)
	Do not wash

Programme selection examples

Programme	Garment care label symbols
Cottons	
Minimum iron	
Automatic plus	
Express 20	
Woollens	
Delicates	



















Drying	
The number of dots indicates the drying temperature.	
	Normal temperature
	Low temperature
	Do not tumble dry

Ironing	
The number of dots indicates the ironing temperature.	
	approx. 200°C
	approx. 150°C
	approx. 110°C
	Do not steam iron garments carrying this symbol as this could cause irreversible damage.
	Do not iron



Professional cleaning	
	Dry clean only. The letters indicate the type of cleaning agent required.
	Professional Wet Clean only
	Do not dry clean

Bleaching	
	Any oxidising bleaching agent can be used
	Only use an oxygen based bleach or a non-chlorine bleach
	Do not bleach

Programme sequence

	Main wash		Rinse		Spin
	Water level	Wash rhythm	Water level	Rinses	
Cottons		(A)		3-4 ¹⁾	✓
Minimum iron		(C)		2-3 ²⁾	✓
Automatic plus		(A)(B)(C)		2-3 ²⁾	✓
Dark garments/Denim		(B)		3	✓
Express 20		(B)		1-3 ²⁾	✓
Shirts		(C)		2	✓
Woolens 		(F)		2	✓
Delicates		(D)		3	✓
Drain/Spin	-	-	-	-	✓
Separate rinse/Starch	-			1	✓

Please see the next page for a description of the symbols.

-  = Low water level
 = Medium water level
 = High water level
Ⓐ = Intensive rhythm
Ⓑ = Normal rhythm
Ⓒ = Gentle rhythm
Ⓓ = Sensitive rhythm
Ⓔ = Ultra sensitive rhythm
Ⓕ = Handwash rhythm
✓ = Carried out
– = Not carried out

The washing machine has fully electronic controls with automatic load recognition. It takes in the right amount of water required for the programme depending on the amount of laundry and its absorbency rate.

The programme sequences outlined in the chart are based on the basic programme with a full load. Extra options which can be selected have not been taken into account.

Special features in the programme sequence

Anti-crease:

At the end of the programme the drum continues to turn at intervals for up to 30 minutes to help prevent creasing.

Exception: There is no anti-crease phase in the *Woolens* programme.

The door can be opened at any time during the anti-crease phase.

¹⁾ A fourth rinse is carried out if:

- there is too much foam in the drum
- a spin speed lower than 700 rpm has been selected
-  is selected

²⁾ A third rinse is carried out if:

-  is selected

Changing the programme sequence

Cancelling a programme

You can cancel a programme at any time after it has started.

- Turn the programme selector to *Finish*.

The water will drain away. The programme is cancelled as soon as the *Anti-crease/Finish* indicator light comes on and  appears in the display.

Selecting a different programme after cancelling the programme

- Switch the washing machine off and then back on with the  button.
- Check that there is still detergent in the dispenser drawer. Add more detergent if necessary.
- Turn the programme selector to the programme you want and start the programme by pressing the *Start* button.

Removing laundry after cancelling the programme

- Turn the programme selector to *Drain/Spin*.



Useful tip: Select an appropriate spin speed.

- Press the *Start* button.

The suds will be pumped away.

- Press the *Door* button to open the drum door.

Interrupting a programme

- Switch the washing machine off with the  button.
- Switch the washing machine back on with the  button to continue with the same programme.

Changing a programme and settings

Programme

After the start of a programme, it is not possible to select a different programme.

Temperature

It is possible to select a different temperature up to six minutes after the programme has started.

Spin speed

It is possible to change the spin speed at any time.

Extras

It is possible to select or deselect the *Water plus Extra* option up to six minutes after the programme has started.

Adding or removing laundry after a programme has started

- Press the *Door* button until the door opens.
- Add or remove items.
- Close the door.

The programme will continue automatically.

Please note:

Once a programme has started, the washing machine cannot recognise any adjustment to the size of the load.

For this reason, if laundry is added or removed after the start of a programme, the machine will always complete the programme cycle assuming a full load.

This can lead to an increase in the time left displayed.

The door cannot be opened if:

- the suds temperature is above **55°C**.
- the water is above a certain level.
- the final spin is being carried out.

Detergent

The correct detergent

All detergents produced for automatic front loading washing machines are suitable. Follow the manufacturer's instructions and dosage recommendations on the packaging.

The right amount to dispense will depend on the following:

- The soiling level of the laundry.
- The quantity of laundry.
- The water hardness level.
Check with your local water supplier if you do not know the water hardness level in your area.

Definition of the soiling level

- Lightly soiled
No visible dirt or stains. Possibly slight body odour.
- Normally soiled
Visibly dirty and/or just a few slight stains.
- Heavily soiled
Stains and soiling clearly visible.

Water hardness levels

Hardness range	Hardness level
soft	< 17 mg/L CaCO ₃
slightly hard	17 – 60 mg/L CaCO ₃
moderately hard	60 – 120 mg/L CaCO ₃
hard	120 – 180 mg/L CaCO ₃
very hard	> 180 mg/L CaCO ₃

Detergent dispensing aids

Use dispensing aids, (e.g. balls) if these are supplied with the detergent, particularly when using liquid detergent.

Refill packs of detergent

When purchasing detergent, buy refill packs wherever possible. This helps reduce the amount of waste packaging.

Water softeners

A water softener can be used to cut down on the use of detergents in areas with water hardness levels II and III. Dispense according to the amount specified on the packaging. First add detergent and then the water softener.

You can then use the recommended amount of detergent for water hardness level I.

Fabric softeners and liquid starch

Fabric softeners

make garments soft to handle and help prevent static cling when tumble drying.

Fabric shapers

are synthetic starches and give an even stiffer hold.

Starch

stiffens and gives body to items of laundry, e.g. shirts, tablecloths and bed linen.

Miele recommended detergents

Miele detergents and care products have been specially designed for Miele washing machines. They are available to order via the internet at www.miele-shop.com (depending on country) or from Miele.

	Miele UltraWhite	Miele UltraColor	Miele WoolCare	Miele fabric softener
Cottons	✓	✓	-	✓
Minimum iron	-	✓	-	✓
Automatic plus	-	✓	-	✓
Dark garments/Denim	-	✓	-	✓
Express 20	-	✓	-	✓
Shirts	✓	✓	-	✓
Woolens (👔)	-	-	✓	✓
Delicates	-	-	✓	✓

- ✓ Recommended
- Not recommended

Detergent

The recommendations apply to the temperature ranges given in the Programme chart.

	Universal	Colour	Delicates and woollens	Special
	detergent			
Cottons	✓	✓	-	-
Minimum iron	-	✓	-	-
Dark garments/Denim	-	✓ ¹⁾	-	✓
Express 20	-	✓ ¹⁾	-	-
Shirts	✓	✓	-	-
Woollens 	-	-	✓	✓
Delicates	-	-	✓	-

✓ Recommended

- Not recommended

1) Liquid detergent

2) Powder detergent

Dispensing fabric softener and liquid starch at the end of the programme

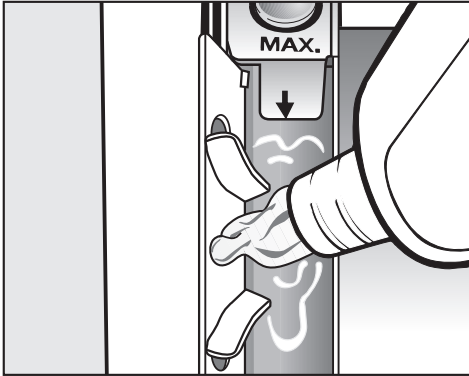

- Add the fabric softener or liquid starch to compartment ☼. **Do not exceed the maximum level mark.**

It will be automatically dispensed in the final rinse. At the end of the programme a small amount of water will remain in the ☼ compartment.

If starching frequently, thoroughly clean the dispenser compartment, especially the siphon tube, regularly.

Adding fabric softener or liquid starch separately

Prepare the starch in accordance with the manufacturer's instructions on the packaging.

- Add fabric softener to the ☼ compartment.
- Add liquid starch to the ☼ compartment and powder or viscous starch to the ⊥ compartment.
- Select the *Separate rinse/Starch* programme.
- Change the spin speed if necessary.
- Press the *Start* button.

Colour run and dye removers/dyes

⚠ **Do not use** colour run or dye removers in this washing machine. They can cause corrosion in the machine.

Dyes suitable for use in domestic washing machines can be used. However, please note that the salt used in the dyeing process can cause corrosion to stainless steel components in the machine if you dye frequently. Always observe the manufacturer's instructions carefully.

Cleaning and care

Cleaning the drum

Washing at low temperatures and/or using liquid detergent can cause bacteria and unpleasant odours to build up in the washing machine. In order to clean the drum and also to prevent unpleasant odours building up, run a programme with a temperature of at least 60°C using powder detergent once a month or when the *Hygiene info* light comes on.

External casing and fascia panel

⚠ Disconnect the machine from the mains electricity supply and withdraw the plug from the socket before cleaning the machine.

⚠ The washing machine must not be hosed down.

- Clean the casing with a mild non-abrasive cleaning agent or soap and water using a well wrung-out cloth. Wipe dry with a soft cloth.
- The drum can be cleaned using a suitable proprietary stainless steel cleaning agent following the manufacturer's instructions on the packaging.

⚠ Do not use solvents, abrasive cleaners, glass cleaners or all-purpose cleaning agents. These might damage plastic surfaces and other components because of the chemicals they contain.

Cleaning the detergent dispenser drawer

The pre-wash and main wash compartments of the detergent dispenser drawer are self-cleaning.

For hygiene reasons, clean the entire drawer at regular intervals.

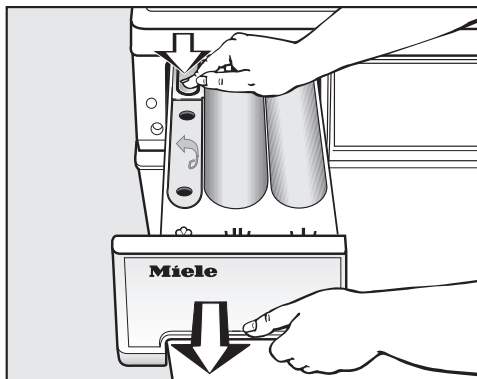

- Pull out the detergent dispenser drawer until a resistance is felt. Press down the release button and at the same time pull the drawer right out of the machine.
- Clean the detergent drawer with warm water.

Cleaning the siphon

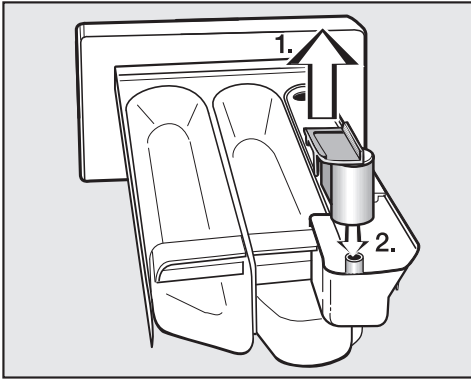

- 1. Remove the siphon from compartment  and rinse under warm running water. Clean the siphon tube in the same way.
- 2. Refit the siphon.

Liquid starch can cause the siphon to become clogged. Make sure that you clean the siphon and siphon tube particularly thoroughly after using liquid starch a few times.

Cleaning the detergent dispenser drawer housing

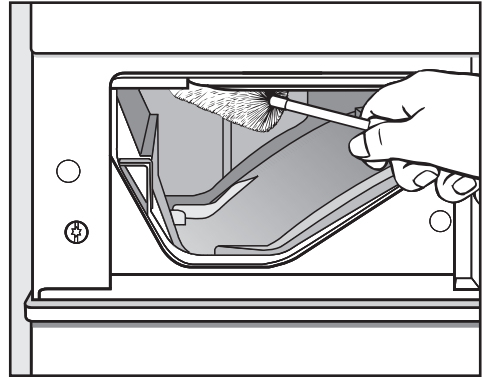

- Use a bottle brush to remove detergent residues and limescale from the jets inside the detergent dispenser drawer housing.

Cleaning and care

Cleaning the water inlet filter

The washing machine has a filter to protect the inlet valve.

The filter in the union in the open end of the inlet hose should be checked every 6 months or so, or more often if there are frequent interruptions to the water supply.

- First turn off the tap.
- Unscrew the inlet hose from the tap.

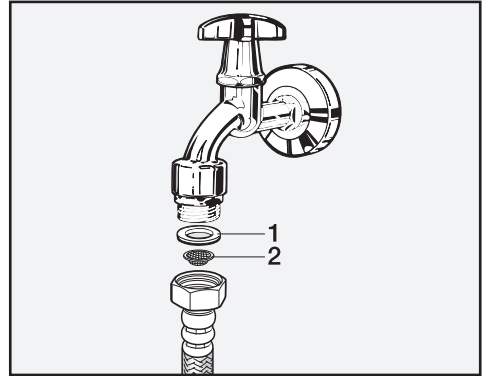

- Remove the rubber seal **1** from the union.
- Hold the free end of the inlet hose downwards. The plastic filter **2** will drop out.
- Clean the plastic filter.
- Put the filter and seal back in the reverse order and reconnect the hose.
- Turn on the tap and check the connection is watertight. If water drips out, tighten the connection.

Never forget to put the filter back in place after cleaning.

Problem solving guide

With the help of the following guide, minor faults in the performance of the appliance, some of which may result from incorrect operation, can be put right without contacting Miele. This will save time and money.

Please note that a call-out charge will be applied to unnecessary service visits where the problem could have been rectified as described in these operating instructions.

 Repair work to electrical appliances should only be carried out by an authorised Miele service technician. Repairs and other work by unqualified persons could be dangerous. Miele cannot be held liable for unauthorised work.

The programme does not start

Problem	Possible cause and remedy
The <i>Anti-crease/Finish</i> indicator light is not on or the <i>Start</i> button is not flashing.	There is no power to the machine. <ul style="list-style-type: none">■ Check whether the mains plug is plugged in and switched on.■ Check whether the fuse or circuit breaker has tripped.■ Check whether the door is closed properly.
	The washing machine has switched off automatically to save energy. <ul style="list-style-type: none">■ Switch it back on with the  button.

Problem solving guide

The wash programme stops and a fault indicator light comes on

Problem	Possible cause and remedy
The <i>Check drainage</i> fault indicator light flashes and a fault number appears in the display.	The water outlet is blocked. ■ Clean the drain filter and the drain pump as described in "Problem solving guide – Opening the drum door in the event of a blocked water outlet and/or a power failure".
	The drain hose has been fixed too high. ■ The maximum drain height is 1 m.
The <i>Check inlet</i> fault indicator light flashes and a fault number appears in the display.	The water inlet is blocked. ■ Turn on the tap.
	The filter in the water inlet hose is dirty. ■ Clean the filter.
The <i>Check inlet</i> and <i>Check drainage</i> fault indicator lights flash and a fault number appears in the display.	The water protection system has reacted. ■ Turn off the tap. ■ Call Miele.
The <i>Soak/Pre-wash</i> or <i>Rinses</i> indicator lights flash in the programme sequence display and a fault number appears in the display.	There is a fault. ■ Start the programme again. If the fault message appears again, contact Miele.

To switch off the fault indicator: Switch the washing machine off with the ① button and turn the programme selector to *Finish*.

A check or fault indicator light comes on but the wash programme continues as normal.

Problem	Possible cause and remedy
The <i>Hygiene info</i> check indicator light comes on.	A programme of at least 60°C has not been run for a long period of time. <ul style="list-style-type: none"> ■ In order to prevent bacteria and unpleasant odours building up in the machine, run the <i>Cottons 90°C</i> programme using powder detergent.
The <i>Check dosage</i> check indicator light comes on.	Excessive foam has built up during washing. <ul style="list-style-type: none"> ■ Use less detergent next time and follow the manufacturer's instructions on dosage given on the packaging.
The <i>Main wash or Rinses</i> indicator lights flash in the programme sequence display and a fault number appears in the display.	The washing machine has detected a fault during the wash programme. <ul style="list-style-type: none"> ■ Start the programme again. If the fault message appears again, contact Miele.
The <i>Anti-crease/Finish</i> indicator light flashes in the programme sequence display.	The programme selector was moved to another position after the programme had started. <ul style="list-style-type: none"> ■ Turn the programme selector back to the original position.

To switch off the fault indicator: Switch the washing machine off with the ① button and turn the programme selector to *Finish*.

The check indicator lights come on at the end of a programme and when the washing machine is switched on.

Problem solving guide

General problems with the washing machine

Problem	Possible cause and remedy
The machine shakes during the spin cycle.	The machine feet are not level. ■ Level the machine and adjust the feet correctly.
The laundry has not been spun properly and the laundry is still wet.	The machine detected an imbalance during the final spin and reduced the spin speed automatically. ■ Include both large and small items in the load as this will give better distribution.
The pump makes strange noises.	This is not a fault. These slurping noises occur at the end of the pump sequence as a normal part of operation.
Large amounts of detergent residue remain in the detergent dispenser drawer.	The water pressure is too low. ■ Clean the filter in the water inlet. ■ It may be useful to select the <i>Water plus</i> Extra option.
	Powder detergent used with water softeners can be sticky. ■ Clean the detergent dispenser drawer and in future add washing powder and then add the water softener.
Fabric softener is not completely dispensed or too much water remains in the  compartment.	The siphon tube is not correctly positioned, or is clogged up. ■ Clean the siphon (see "Cleaning and care - Cleaning the detergent dispenser drawer").

An unsatisfactory wash result

Problem	Possible cause and remedy
<p>Liquid detergent does not give the required result.</p>	<p>Liquid detergents usually contain no bleaching agents. They do not remove fruit, coffee and tea stains.</p> <ul style="list-style-type: none"> ■ Use a general purpose detergent containing a bleaching agent. ■ Never put stain removers and liquid detergent together in the  compartment. ■ Never put stain removers and liquid detergent together in the dispenser drawer.
<p>Grey, greasy particles cling to washed laundry.</p>	<p>Insufficient amounts of detergent were used to break down the particles of grease in heavily soiled laundry.</p> <ul style="list-style-type: none"> ■ Use more detergent or liquid detergent. ■ Before washing the next load, run a Cottons 60°C programme with powder detergent but without a load.
<p>White residues which look like powder detergent are seen on dark textiles after washing.</p>	<p>The detergent contained compounds (zeolites) to aid water softening which are not soluble in water. These have ended up on the laundry.</p> <ul style="list-style-type: none"> ■ Try and brush off the residues with a soft brush once the laundry is dry. ■ Wash dark textiles using a detergent which does not contain zeolites. Liquid detergents usually do not contain zeolites. ■ Use the <i>Dark garments/Denim</i> programme.

Problem solving guide

The door will not open

Problem	Possible cause and remedy
The drum door cannot be opened by pressing the <i>Door</i> button.	The machine is not connected to the electricity supply and/or is not switched on. ■ Insert the plug in the socket and switch on, and/or switch the machine on with the Ⓛ button.
	Power cut. ■ Open the door as described in “Opening the door in the event of a blocked drain outlet and/or power failure”.
	The door was not correctly engaged. ■ Press hard against the lock side of the door and then press the <i>Door</i> button.
	There is still water in the drum and the machine is unable to drain. ■ Clean the drain filter and the drain pump.
	For safety reasons, the door cannot be opened if the suds temperature is higher than 55°C. ■ Allow the programme to finish or cancel it and wait until the temperature in the drum has dropped.

Opening the door in the event of a blocked drain outlet and/or power cut

- Switch off the washing machine.

There is a lever behind the detergent drawer fascia panel for opening the access panel to the drain filter.

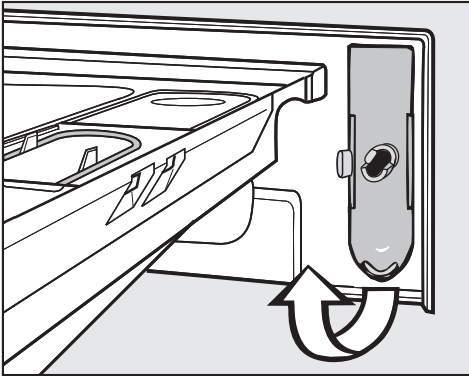

- Remove the lever.

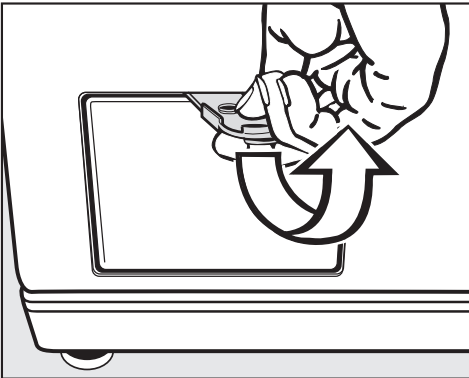

- Use it to open the access panel.

Blocked drain outlet

If the drain outlet is blocked, a large quantity of water (**up to 25 litres**) can remain in the washing machine.

⚠ Caution: If laundry has been washed at a high temperature, water draining out of the machine will still be hot. Danger of scalding!

Procedure for draining the washing machine

- Place a suitable container under the access flap.

When draining water from the machine, do not unscrew the drain filter completely or take it right out.

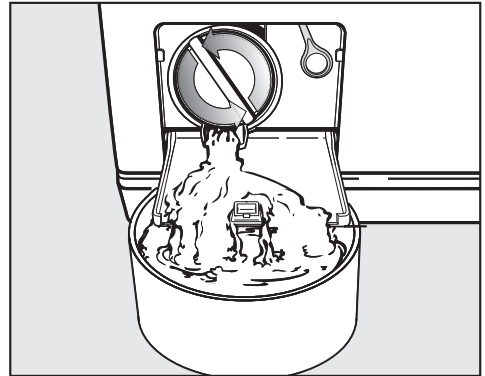

- Slowly and carefully unscrew the drain filter to let the water out. Be careful not to release too much water at once. If the flow of water is too strong, some water can seep into the washing machine base and activate the water protection float switch. This will prevent the washing machine from functioning.

Problem solving guide

- Tighten the drain filter back up again if you need to interrupt the flow of water.

Once the flow of water ceases:

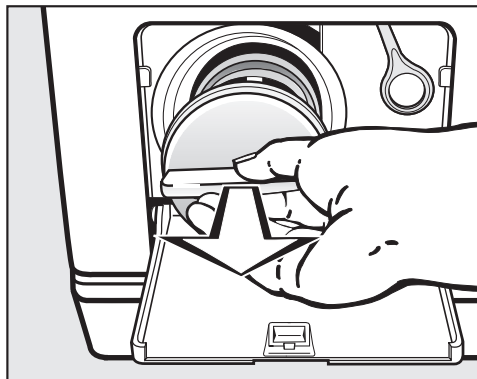

- Remove the drain filter completely.
- Clean it thoroughly.

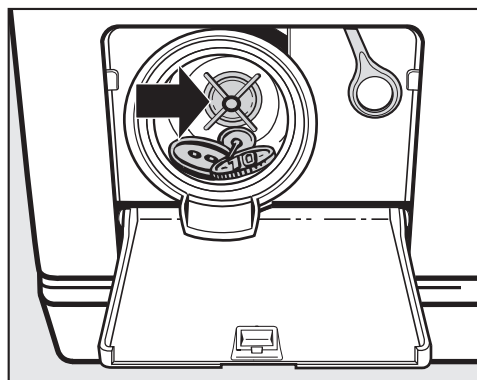

- Remove any foreign objects (e.g. buttons, coins, etc.) and fluff from the filter housing. Turn the impeller by hand to check that it rotates freely.
- Put the drain filter back in place and secure it.

⚠ Make sure the drain filter is securely tightened. Otherwise there is a risk of water leakage during use.

To avoid loss of detergent, pour approx. 2 litres of water into the detergent dispenser drawer after cleaning the drain filter. Excess water will be pumped out automatically before the next wash programme.

Opening the door

⚠ Always make sure that the drum is stationary before reaching in to remove laundry. Reaching into a moving drum is extremely dangerous.

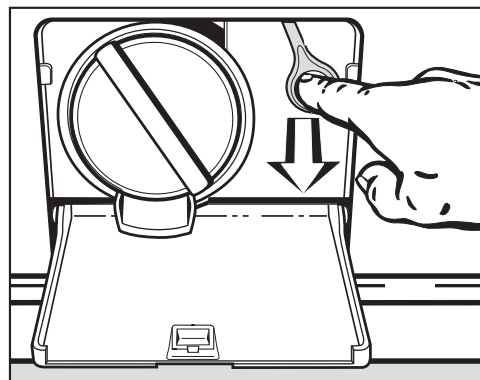

- Pull the emergency release downwards. The door will open.

Repairs

In the event of any faults which you cannot remedy yourself, please contact Miele.

The contact details for Miele are given at the back of these instructions.

When contacting Miele, please quote the model and serial number of your machine, both of which are visible on the data plate above the porthole glass when the door is open.

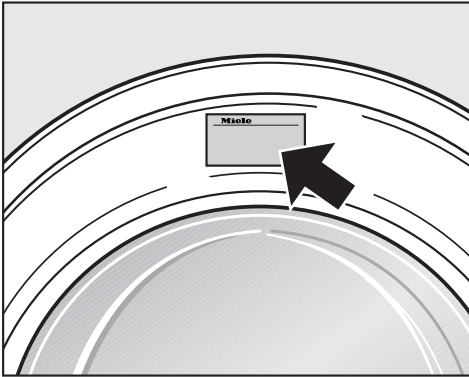

Warranty

The manufacturer's warranty for this appliance is 2 years.

See the warranty card supplied with the washing machine for further details.

Optional accessories

Optional spare parts and accessories for this washing machine are available from Miele.

Installation and connection

Front view

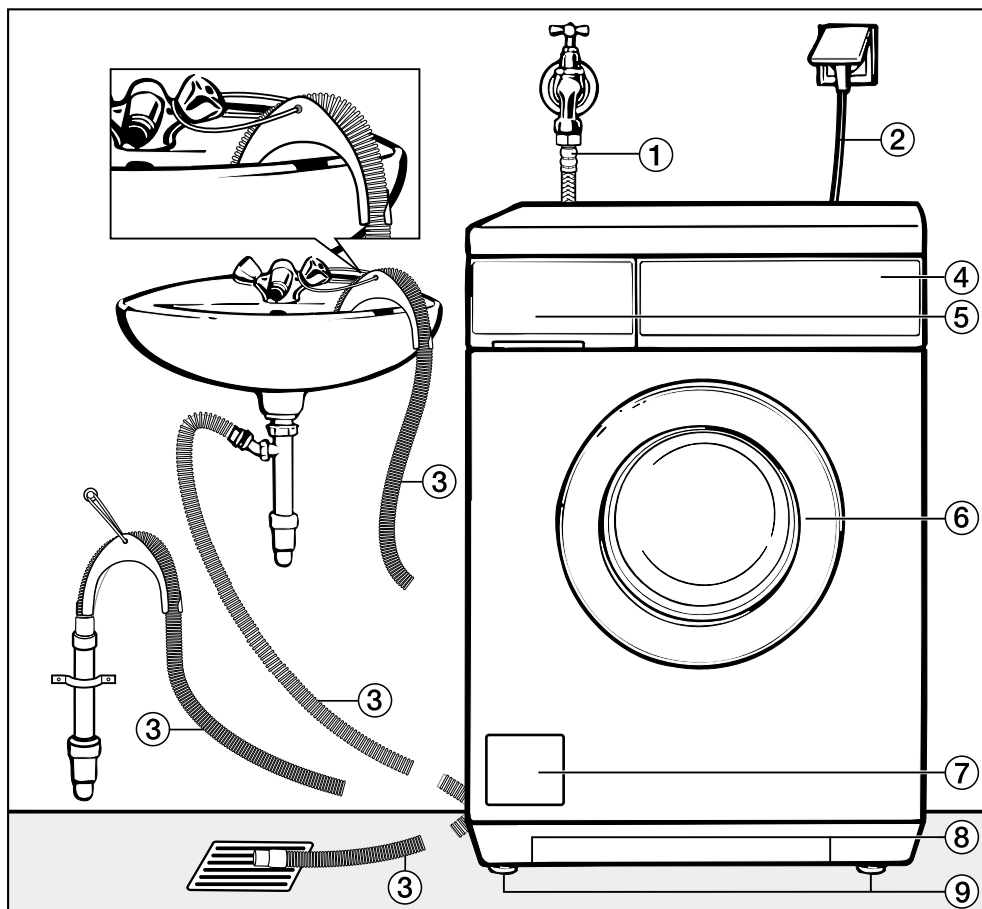

- ① Waterproof metal inlet hose (braided)
- ② Electrical connection
- ③ Flexible drain hose (with detachable swivel elbow)
- ④ Control panel
- ⑤ Detergent dispenser drawer
- ⑥ Drum door
- ⑦ Access to drain filter, drain pump and emergency release
- ⑧ Handle recesses for moving the machine
- ⑨ Four height adjustable feet

Installation and connection

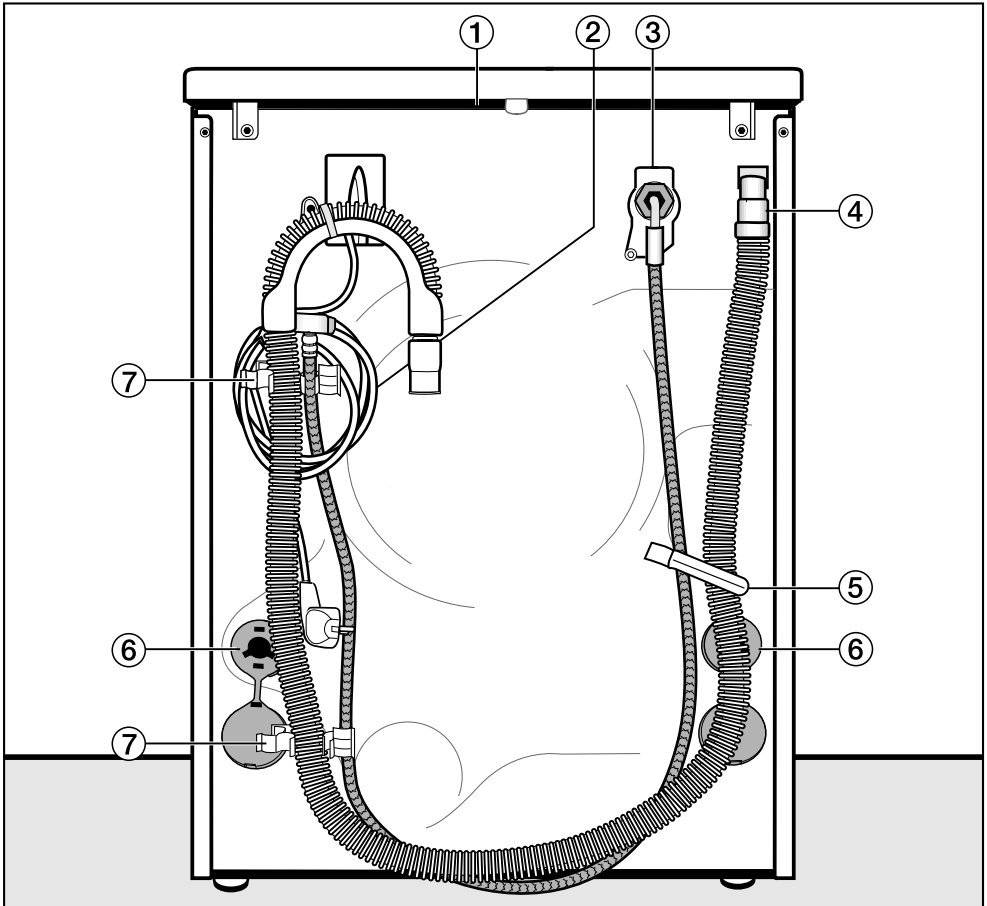

- ① Protruding lid for holding when moving the machine
- ② Electrical connection
- ③ Waterproof metal inlet hose (braided)
- ④ Drain hose
- ⑤ Transport brackets for inlet and drain hoses
- ⑥ Transit bar covers
- ⑦ Transport brackets for inlet and drain hoses and restraining clips for transit bars when not in use

Installation and connection

Installation surface

A concrete floor is the most suitable installation surface for a washing machine, being far less prone to vibration during the spin cycle than wooden floorboards or a carpeted surface.

Please note:

- The machine must be level and securely positioned.
- To avoid vibrations during spinning, the machine should not be installed on soft floor coverings.

If installing on a wooden joist floor:

- We recommend a plywood base (at least 59 x 52 x 3 cm). The base should span several joists and be bolted to the joists and not only to the floorboards. Check for the presence of pipes and cables first.

Useful tip: If possible, install the machine in a corner, as this is usually the most stable part of the floor.

Transporting the washing machine to its installation site

To manoeuvre the washing machine out of its packing case to its installation site, hold it by the edge of the lid where it protrudes to the rear of the machine as well as by the handle recesses at the front.

⚠ Ensure that the machine feet and the floor are dry to prevent the machine from slipping during the spin cycle.

Removing the transit bars

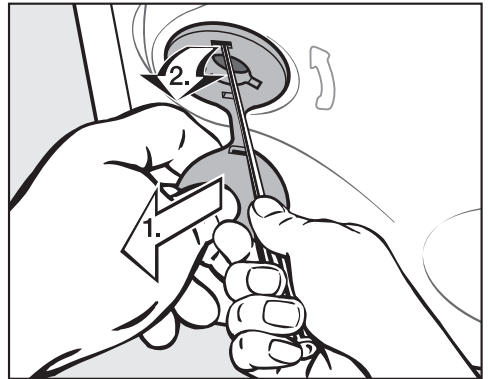

- Remove the left and right covers.
 1. Pull off the transit bar covers and
 2. then use a screwdriver to release the catches at the top and bottom.

Installation and connection

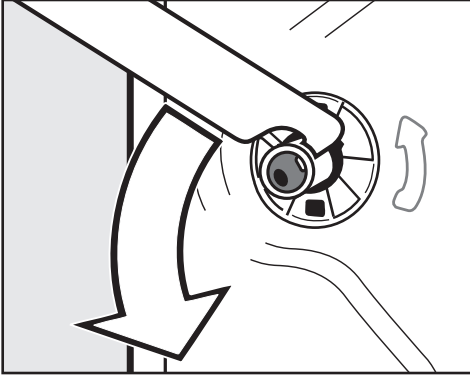

- Using the spanner supplied, turn the left-hand transit bar 90°, then

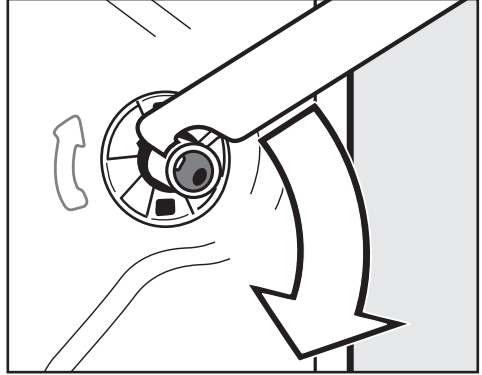

- Turn the right-hand transit bar 90°, then

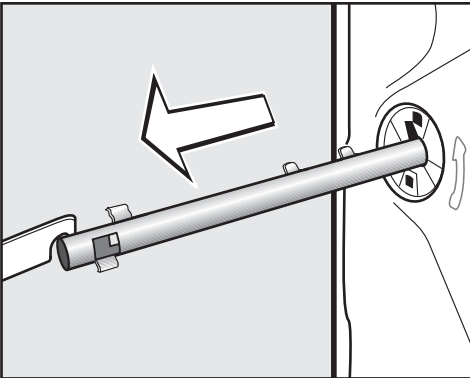

- withdraw the transit bar.

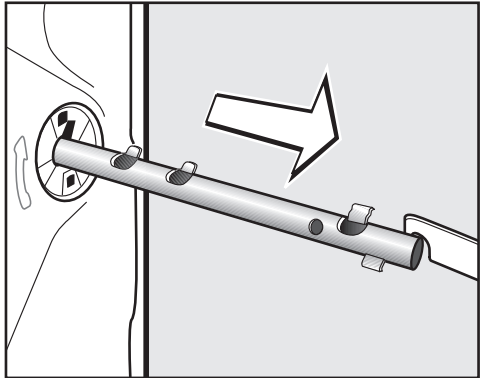

- withdraw the transit bar.

Installation and connection

 To avoid the risk of injury, the holes for the transit bars must be covered after the transit bars have been removed.

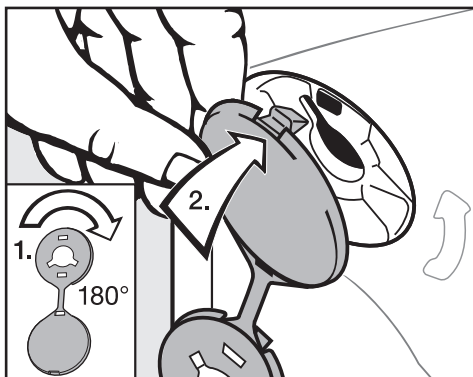

- Fit the covers onto the two holes.

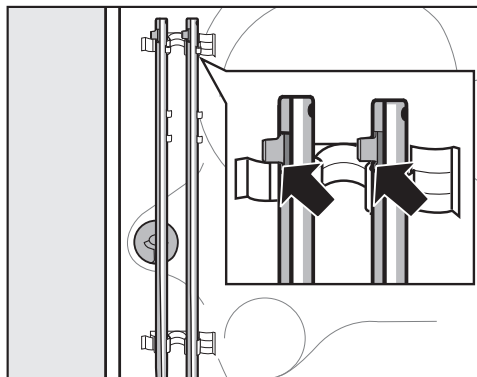

- Secure the transit bars to the back of the washing machine. Make sure the top catch is located above the holder.

 The washing machine must not be moved without the transit bars in place. Store them as shown or keep them in a safe place for future use. They must be refitted if the machine is to be moved again (e.g. when moving house).

Refitting the transit bars

Refitting is carried out by reversing the procedure.

Levelling the machine

The washing machine must stand perfectly level on all four feet to ensure safe and proper operation.

Incorrect installation may increase electricity and water consumption and may cause the machine to move about.

Screwing out and adjusting the feet

The four adjustable screw feet are used to level the machine. All four feet are screwed in when the machine is delivered.

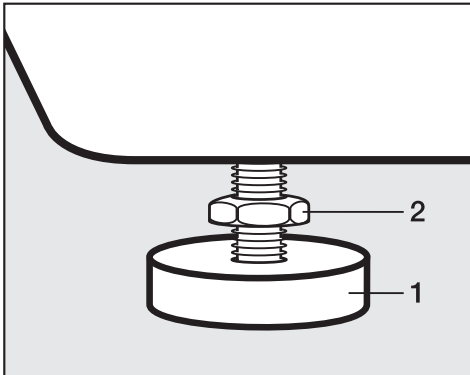

- Using the spanner supplied, turn counter nut **2** in a clockwise direction. Then turn counter nut **2** together with foot **1** to unscrew.

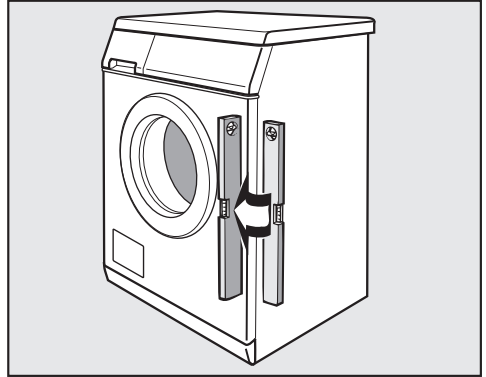

- Use a spirit level to check that the washing machine is standing level.
- Hold foot **1** securely with a pipe wrench. Turn counter nut **2** again using the spanner supplied until it sits firmly up against the housing.

 All four counternuts must be firmly up against the housing. Please also check this for the feet which did not need adjustment. Otherwise there is a danger of the machine moving about.

Installation and connection

Building under a continuous worktop / in a kitchen run

The fitting of cover plates and stacking kits must only be undertaken by qualified and competent persons, in accordance with the instructions supplied with the kit.

- A special building under conversion kit* is required. The machine lid must be replaced by a coverplate. To ensure electrical safety, the cover plate must be fitted.*
- N.B.*
If you wish to push your machine under a worktop and there is space to do this **without removing the lid**, the conversion kit is not necessary. Otherwise the conversion kit is essential.
- Connections for electricity, water and drainage should be installed in such a way that they remain accessible when the machine is in place.

Fitting instructions are supplied with the conversion kit.

Washer and dryer stack

A Miele tumble dryer can be stacked with the washing machine. The appropriate "WTV" stacking kit* to match your tumble dryer is required.

All parts marked * are available from Miele.

Please note:

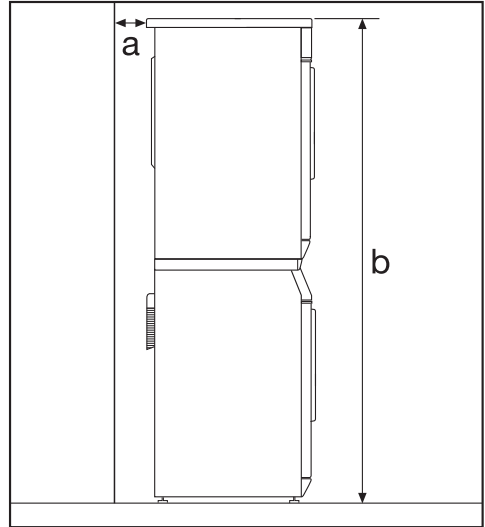

- a** Safety distance to wall
at least 2 cm
- b** Height:
Stacking kit with pull-out shelf:
approx. 169 cm
Stacking kit without pull-out shelf:
approx. 170 cm

The Miele water protection system

The Miele water protection system protects all parts of the washing machine and surrounds from water damage.

The system consists of three main components:

- the inlet hose
- the electronic unit and drainage and overflow protection
- the drain hose

Inlet hose

- Protection against bursting.
The inlet hose is tested to withstand pressure of at least 14,000 kPa.
- Protective sleeve.
The inlet hose has a braided metal "second skin" to protect it from damage.

Electronic unit and washing machine housing

- Sump: Any leaking water is collected in a sump in the base of the machine. A float switches off the water inlet valves, preventing any more water from flowing into the machine and water in the suds container is pumped away.
- Overflow protection: This prevents the washing machine taking in too much water. If the water level exceeds a certain level, the drain pump switches on and pumps the excess water away in a controlled way.

Drain hose

The drain hose is protected by a ventilation system which prevents the washing machine from being emptied completely.

Installation and connection

Connection to the water supply

The washing machine should be connected to a mains water supply in accordance with current local and national safety regulations.

IMPORTANT Australia and New Zealand

This appliance must be installed according to AS/NZS 3500.1. Backflow prevention is already integrated in the appliance.

The machine is designed to operate with a flow pressure of between 100 and 1000 kPa. If it is higher than 1000 kPa, it is essential to fit a reducer valve.

Connection to the mains water supply should incorporate a mains tap with $\frac{3}{4}$ " threaded union. The tap should be fitted by a qualified plumber.

 The connection point is subject to mains water pressure. Turn on the tap slowly and check for leaks. Correct the position of the washer and union if appropriate.

The washing machine is not suitable for connection to a hot water supply.

Maintenance and care

Only use a genuine Miele hose should you ever need a replacement. These are tested to withstand pressures of at least 14000 kPa.

The dirt filter in the open end of the inlet hose must not be removed.

Drainage

The machine drains via a drain pump with a delivery head of 1 metre. The drain hose must not be kinked as this restricts drainage. The swivel elbow at the end of the hose can be turned in either direction, or can be detached if required, with a sharp twist and pull. If required, the drain hose can be extended to a length of 5 m. The necessary parts can be purchased from Miele.

For a delivery head of more than 1 m (up to a max. of 1.8 m) a replacement drain pump will need to be fitted. Please contact Miele for advice.

If necessary, the drain hose can be extended to a length of 2.5 m. The necessary parts can be purchased from Miele.

Drain hose connection:

1. Direct into a sink or basin:

Please note:

- Hook the hose over the edge and secure.
- Make sure that the water can drain away freely without hindrance. Otherwise there is a risk of water overflowing or of some of the drained water being sucked back into the machine.

2. Connected securely to a plastic drain pipe with a rubber nipple. There is no need to use a siphon.

3. Connected securely to a floor gully.

4. Connected securely to a standpipe.

Please note:

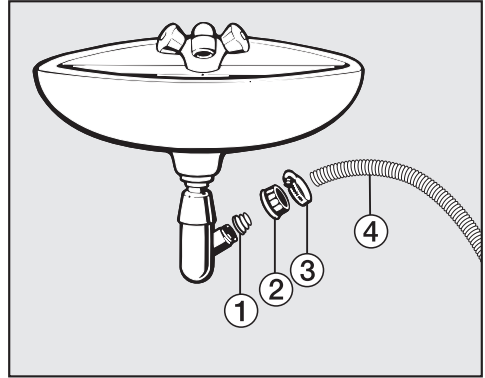

① Adapter

② Nut

③ Hose clip

④ End of the hose

- Fit the adapter ① to the sink drain outlet using the nut ②.
- Attach the end of the hose ④ to the adapter ①.
- Use a screwdriver to tighten the hose clip ③ up close to the nut.

Installation and connection

Electrical connection

The washing machine is supplied with a mains cable with moulded plug for connection to a 230V mains supply. The voltage, rated load and plug rating are given on the data plate. Please ensure these match the household mains supply.

WARNING: THIS APPLIANCE MUST BE EARTHED

 The accessibility of the plug must always be ensured in order to separate the washing machine from the mains. Do not connect the appliance to an extension lead or multi-socket adapter as they do not guarantee the required safety of the appliance (e.g. danger of overheating).

All electrical work should be carried out only by a suitably qualified and competent person, in strict accordance with national and local safety regulations. For extra safety, it is advisable to install a residual current device (RCD), with a trip current of 30 mA. Ensure power is not supplied to the appliance until after installation work has been carried out. Connection should be made via a suitable switched socket.

If the connection cable is damaged, it must be replaced with a Miele cable of the same type by a Miele approved service technician only.

Technical data

Height	850mm
Width	595mm
Depth	610mm
Depth with door open	987mm
Height for building under	820mm
Width for building under	600mm
Depth for building under	600mm
Weight	Approx. 94 kg
Capacity	7 kg dry laundry
Voltage	See data plate
Rated load	See data plate
Fuse rating	See data plate
Consumption data	See "Consumption data"
Water flow pressure minimum	100 kPa
Water flow pressure maximum	1000 kPa
Inlet hose length	1.60 m
Drain hose length	1.50 m
Connection cable length	1.60 m
Drain pump head max.	1.00 m
Drain pump length max.	5.00 m
LEDs	Class 1
Test certificates awarded	See data plate
Power consumption when switched off	0.30 W
Power consumption when not switched off	1.00 W

Consumption data

Consumption data for the nominated energy labelling programme according to AS/NZS 2040.1 & AS/NZS 2040.2

	Load	Consumption data		
		Energy in kWh	Water in litres	Duration Normal Cold Water
Cottons $\leq 40^{\circ}\text{C}$	7.0 kg	0.62	60	3 h 14 min

Notes for test institutes:

Detergent **must** be dispensed via the detergent dispenser drawer.

Consumption data can vary from the nominal values given depending on water pressure, water hardness, water inlet temperature, room temperature, type and volume of load, fluctuations in the electricity supply and any Extra options selected.

Consumption data

		Load	Consumption data		
			Energy in kWh	Water in litres	Duration
Cottons	90°C	7.0 kg	2.10	57	2 h 46 min
	60°C	7.0 kg	1.25	57	2 h 16min
	60°C	3.5 kg	1.00	49	–
	<60°C	7.0 kg	0.83	57	3 h 16 min
	40°C	7.0 kg	0.87	57	2 h 22 min
Minimum iron	40°C	3.5 kg	0.60	49	1 h 59 min
Automatic plus	40°C	5.0 kg	0.52	62	1 h 29 min
Express 20	40°C	3.5 kg	0.32	30	20 min
Shirts	40°C	2.0 kg	0.50	42	54 min
Woolens 	30°C	2.0 kg	0.23	39	39 min
Delicates	30°C	2.0 kg	0.38	69	59 min

Consumption data can vary from the nominal values given depending on water pressure, water hardness, water inlet temperature, room temperature, type and volume of load, fluctuations in the electricity supply and any options selected.

For labelling parameters conforming to AS/NZS 2040.1 & AS/NZS 2040.2, please refer to the previous page of this booklet.

Programmable functions

The programmable functions are used to alter the machine's electronics to suit changing requirements. Programmable functions can be altered at any time.

Water plus system

This programmable function is used to specify one of three options for the *Water plus* button.

P1:

(Factory default setting)

The water level is increased in the wash and rinse stages.

P2:

An extra rinse is carried out.

P3:

The water level is increased in the wash and rinse stages and an extra rinse is carried out.

Follow steps ① to ⑦ to programme and store in memory.

The programmable functions are accessed via the Start button and the programme selector.

Before you begin, ensure the following:

- The washing machine is switched off.
- The machine door is closed properly.
- The programme selector is at *Finish*.

- ① Press the *Start* button and keep it pressed in whilst carrying out steps ② to ③.
 - ② Switch machine on with the ① button.
 - ③ Wait until the indicator light for the *Start* button lights up constantly . . .
 - ④ . . . and then release the Start button.
 - ⑤ Turn the programme selector to *Cottons 60°C*.
- A *P* will flash in the display alternating with the number 1, 2 or 3.
- ⑥ Each subsequent press on the *Start* button selects a different option and *P* will flash alternately in the display with the number of the option selected.
 - ⑦ Switch the washing machine off with the ① button.

Gentle action

Activating gentle action reduces the drum action and is suitable for washing lightly soiled items more gently.

Gentle action can be activated for the Cottons and the Minimum iron programmes.

The washing machine is delivered with the Gentle action setting deactivated.

Follow steps ① to ⑦ to programme and store in memory.

The programmable functions are accessed via the Start button and the programme selector.

Before you begin, ensure the following:

- The washing machine is switched off.
- The machine door is closed properly.
- The programme selector is at *Finish*.

- ① Press the *Start* button and keep it pressed in whilst carrying out steps ② to ③.
- ② Switch machine on with the ① button.
- ③ Wait until the indicator light for the *Start* button lights up constantly . . .
- ④ . . . and then release the Start button.
- ⑤ Turn the programme selector to *Cottons* $\langle 60^{\circ}\text{C} \rangle$:
A *P* will flash in the display alternating with the number $\bar{0}$ or $\bar{1}$.
- ⑥ Pressing the *Start* button switches the programmable function on or off. If *P* flashes in the display alternating with the number $\bar{1}$, the programmable function is switched on. If *P* flashes in the display alternating with the number $\bar{0}$, the programmable function is switched off.
- ⑦ Switch the washing machine off with the ① button.

Programmable functions

Suds cooling

When this is activated, additional water flows into the drum at the end of the main wash to cool the suds down. Hot suds can damage plastic drainage pipes.

Suds cooling takes place when the Cottons 90°C programme is selected.

Suds cooling should be activated:

- to prevent the danger of scalding if the drain hose is hooked over the edge of a sink or basin.
- where the drainage pipes do not comply with DIN 1986.
- The machine is delivered with Suds cooling deactivated.

Follow steps ① to ⑦ to programme and store in memory.

The programmable functions are accessed via the Start button and the programme selector.

Before you begin, ensure the following:

- The washing machine is switched off.
- The machine door is closed properly.
- The programme selector is at *Finish*.

- ① Press the *Start* button and keep it pressed in whilst carrying out steps ② to ③.
- ② Switch machine on with the ① button.
- ③ Wait until the indicator light for the *Start* button lights up constantly . . .
- ④ . . . and then release the Start button.
- ⑤ Turn the programme selector to *Cottons 40°C*.
A P will flash in the display alternating with the number 0 or 1.
- ⑥ Pressing the *Start* button switches the programmable function on or off. If *P* flashes in the display alternating with the number 1, the programmable function is switched on. If *P* flashes in the display alternating with the number 0, the programmable function is switched off.
- ⑦ Switch the washing machine off with the ① button.

Memory

If an Extra option is selected for a programme and/or the spin speed is altered, the washing machine stores these changes in memory at the start of a programme.

When that particular programme is chosen again, the washing machine will display the extra option and/or the spin speed which have been stored for that programme in memory.

The machine is delivered with the memory function deactivated.

Follow steps ① to ⑦ to programme and store in memory.

The programmable functions are accessed via the Start button and the programme selector.

Before you begin, ensure the following:

- The washing machine is switched off.
- The machine door is closed properly.
- The programme selector is at *Finish*.

- ① Press the *Start* button and keep it pressed in whilst carrying out steps ② to ③.
- ② Switch machine on with the ① button.
- ③ Wait until the indicator light for the *Start* button lights up constantly . . .
- ④ . . . and then release the Start button.
- ⑤ Turn the programme selector to *Cottons* $\langle 40^{\circ}\text{C} \rangle$.

A *P* will flash in the display alternating with the number $\bar{0}$ or $\bar{1}$.

- ⑥ Pressing the *Start* button switches the programmable function on or off. If *P* flashes in the display alternating with the number $\bar{1}$, the programmable function is switched on. If *P* flashes in the display alternating with the number $\bar{0}$, the programmable function is switched off.
- ⑦ Switch the washing machine off with the ① button.

Programmable functions

Soak duration

A soak duration of between 30 minutes and 2 hours can be programmed in 30-minute increments for the *Soak* button.

If the *Soak Extra* option is selected, the soaking process will be carried out for the duration set before the wash programme is run.

The machine is delivered with a 2-hour duration set for the *Soak* button.

Follow steps ① to ⑦ to programme and store in memory.

The programmable functions are accessed via the *Start* button and the programme selector.

Before you begin, ensure the following:

- The washing machine is switched off.
- The machine door is closed properly.
- The programme selector is at *Finish*.

- ① Press the *Start* button and keep it pressed in whilst carrying out steps ② to ③.
- ② Switch machine on with the ① button.
- ③ Wait until the indicator light for the *Start* button lights up constantly . . .
- ④ . . . and then release the *Start* button.
- ⑤ Turn the programme selector to *Cottons 30°C*.

A *P* will flash in the display alternating with the number 1, 2, 3 or 4.

- 1 = 2 h soak duration (factory default setting)
- 2 = 1 h 30 min soak duration
- 3 = 1 h soak duration
- 4 = 30 min soak duration

- ⑥ Each subsequent press on the *Start* button selects a different option and *P* will flash alternately in the display with the number of the option selected.
- ⑦ Switch the washing machine off with the ① button.

Detergent, fabric care, additives and machine care products are available for this washing machine. All the products have been designed for Miele washing machines.

These and many other useful products can be ordered via the internet at www.miele-shop.com (depending on country) or from Miele (see end of this booklet for contact details).



Detergent

UltraWhite

- Powder detergent
- Suitable for white and light coloured laundry as well as heavily soiled cotton items
- Effective stain removal even at low temperatures

UltraColor

- Liquid detergent for coloured items
- Suitable for coloured and dark/black items
- Protects bright colours from fading
- Effective stain removal even at low temperatures
- Also available as a powder detergent.

Sensitive Skin powder

- High quality detergent formulated for people with sensitive skin
- Contains no dyes and preservatives
- Most suitable for white or light coloured textiles

Specialist detergents

WoolCare

- Liquid detergent for woollens and delicates
- Includes a special wheat protein conditioning formula
- Helps prevent pilling
- Gentle on colours
- Cleans at temperatures as low as 20°C, helps retain the shape of delicate items and protect colours

Sportswear

- Liquid detergent for sportswear and fleece garments
- Neutralises unpleasant odours
- Retains the shape of the textiles

Down Items

- Liquid detergent suitable for pillows, sleeping bags and down filled items
- Retains the elasticity of down and feather filled items
- Retains the breathability of down filled items
- Prevents down filling clumping together

Optional accessories

Fabric care

Fabric Softener

- Fresh, natural fragrance
- Makes laundry soft to handle

Machine care products

Dishwasher and washing machine cleaner

- For cleaning the washing machine thoroughly and effectively
- Removes grease, bacteria and unpleasant odours

Descaler for washing machines

- Removes heavy limescale deposits
- Mild and gentle with natural citric acid

Miele Australia Pty. Ltd.

ACN 005 635 398
ABN 96 005 635 398

Miele Center and Head Office Melbourne:

1 Gilbert Park Drive
Knoxfield, VIC 3180

Miele Center and Office Melbourne:

206-210 Coventry Street
South Melbourne, VIC 3205

Miele Center and Office Sydney:

3 Skyline Place
Frenchs Forest, NSW 2086

Miele Center and Office Brisbane:

39 Harvey Street North
Eagle Farm, QLD 4009

Miele Center and Office Adelaide:

83-85 Sir Donald Bradman Drive
Hilton, SA 5033

Miele Center and Office Perth:

205-207 Stirling Highway
Claremont, WA 6010



www.miele.com.au



Miele New Zealand Limited

IRD 98 463 631

Head Office:

Level 2, 10 College Hill
Freemans Bay, Auckland 1011

Miele Center Auckland:

8 College Hill
Freemans Bay, Auckland 1011

Telephone:

0800 4 MIELE (0800 464 353)

www.miele.co.nz

Miele Global Headquarters

Germany

Miele & Cie. KG

Carl-Miele-Straße 29
33332 Gütersloh
Federal Republic of Germany

WDA 210 WPM



en-AU, NZ

M.-Nr. 09 985 910 / 01